

CRANEMAX[®]

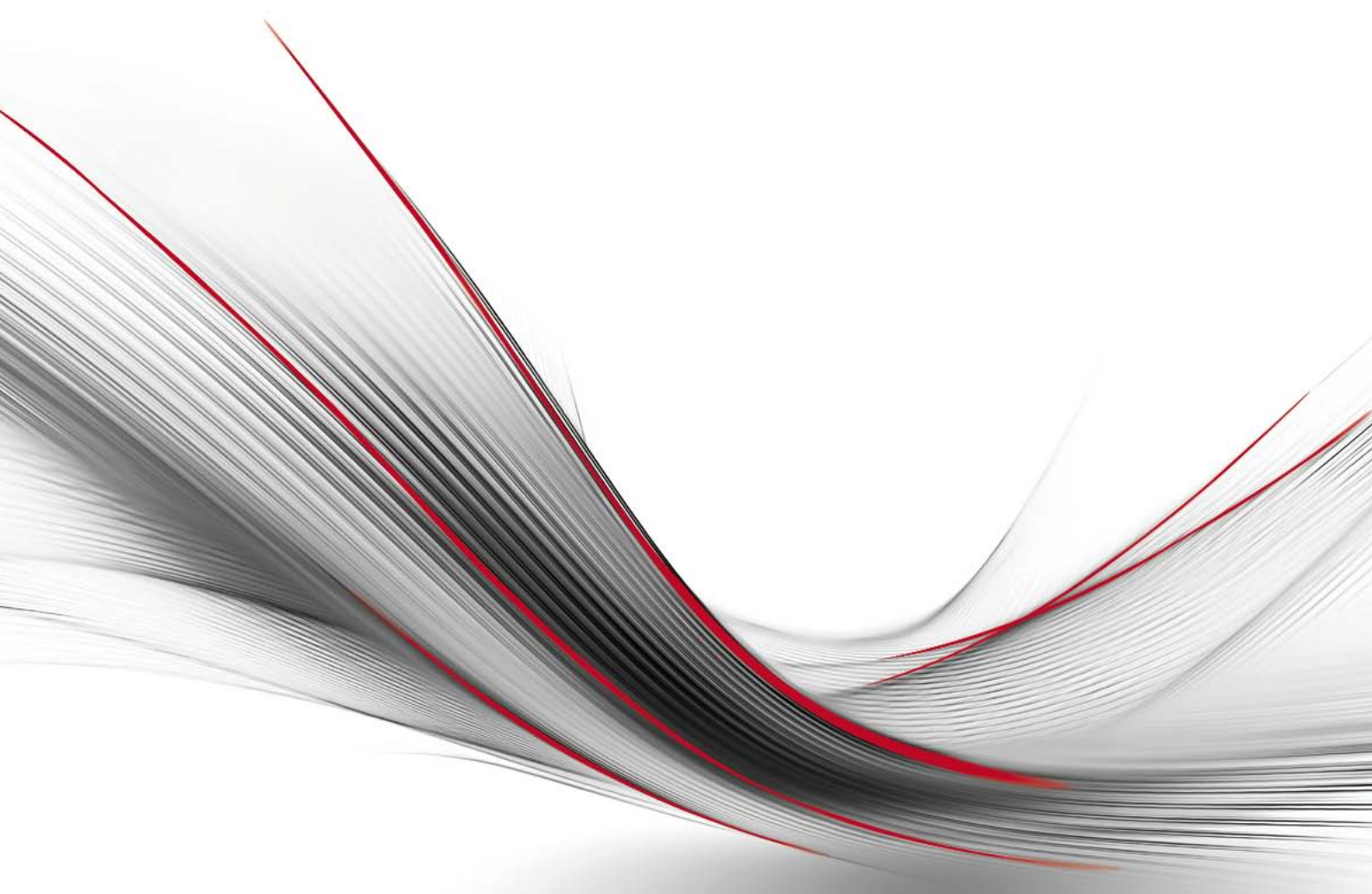

BruntonShaw
STRENGTH IN SERVICE

**ROPES FOR
INDUSTRIAL APPLICATIONS**



	Next generation steel wire ropes for industrial lifting.....	02
	Usha Martin Group.....	03
	Wire rope application selector.....	04
■	CRANEMAX XS6K.....	06
	CRANEMAX S6 and S8.....	07
	CRANEMAX S6K.....	08
	CRANEMAX M35K.....	09
■	CRANEMAX M6K.....	10
	CRANEMAX L8K.....	11
	CRANEMAX L10K.....	12
	CRANEMAX XL8K.....	13
	CRANEMAX XL10K.....	14
■	CRANEMAX XS35.....	15
	CRANEMAX S19K.....	16
	CRANEMAX M10K.....	17
	CRANEMAX L24K.....	18
	CRANEMAX XL35K.....	19
■	CRANEMAX L8KE.....	20
	CRANEMAX XL10KE.....	21
	General rope characteristics.....	22
	Strength and breaking force.....	23
	Material and surface finish.....	24
	Rope storage and handling.....	25
	Rope installation and training.....	26
	Typical rope damage.....	27
	References.....	28

- Shock resistant
- Special hoist
- Rotation & spin resistant
- Electric hoist

NEXT GENERATION STEEL WIRE ROPES FOR INDUSTRIAL LIFTING

With decades of experience in manufacturing speciality ropes, Brunton Shaw has undertaken a major expansion program to develop the next generation of steel wire ropes for industrial applications under a new brand name.

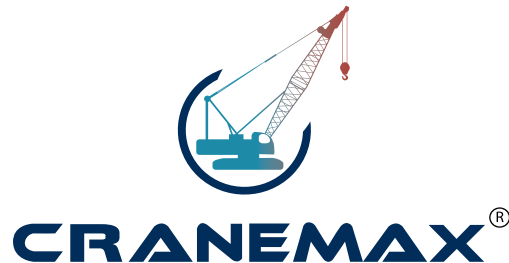

These ropes are designed and manufactured to the very strict technical specifications demanded by our customers for today's challenging conditions. This catalogue shows a variety of ropes for the most common industrial applications and is divided into four key categories:

- Shock resistant
- Special hoist
- Rotation & spin resistant
- Electric hoist

Each type is identified by few letters (**XS, S, M, L, XL**) corresponding to the level of load factor, followed by a number indicating the rope construction. The final letter identifies compacted strand ropes (K) or electric winch ropes (E). These codes can be used as a guideline for rope selection depending on the desired application.

For any additional or special requests, our technical experts are available to provide all the support that customers may need.

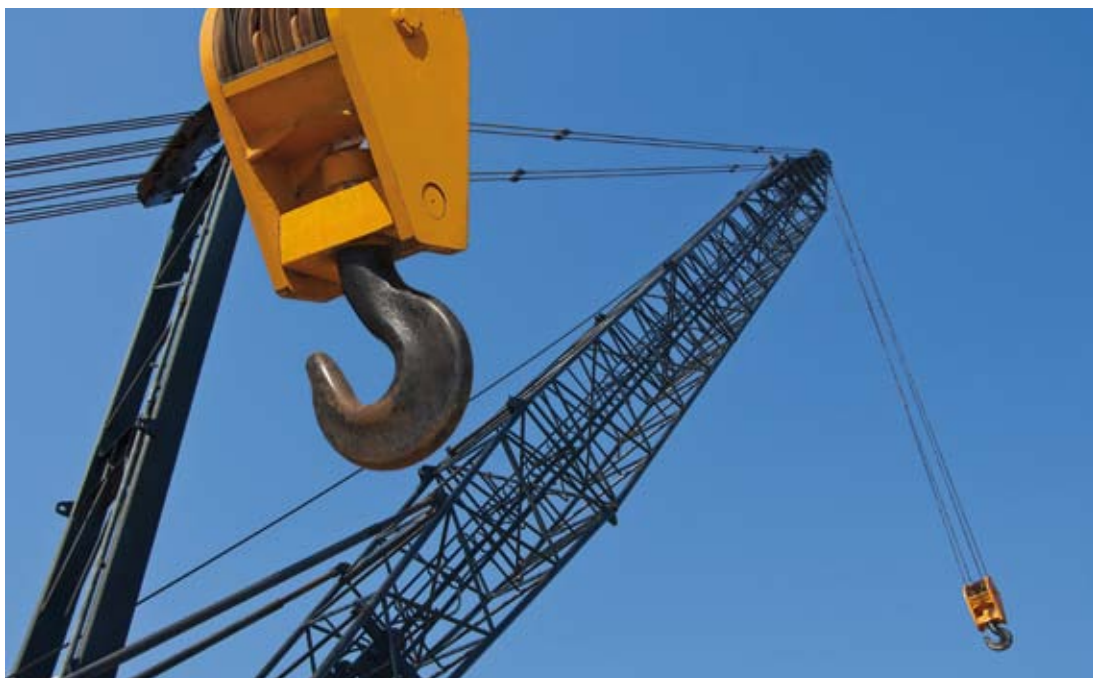

Usha Martin is one of the largest manufacturers of high quality wire ropes in the world. For more than 50 years, the group has been dedicated to excellence and has implemented stringent process controls at each step of the manufacturing process.

The Usha Martin Group, with its own coal and iron ore mines, 150 MW power plant and over 1 million tons of speciality steel manufacturing capacity, is a truly vertically integrated business. It has a global base of steel wire rope manufacturing facilities located in India, the UK, Thailand and Dubai with service centres spread over all of the key markets in Europe, Asia, Americas and Africa.

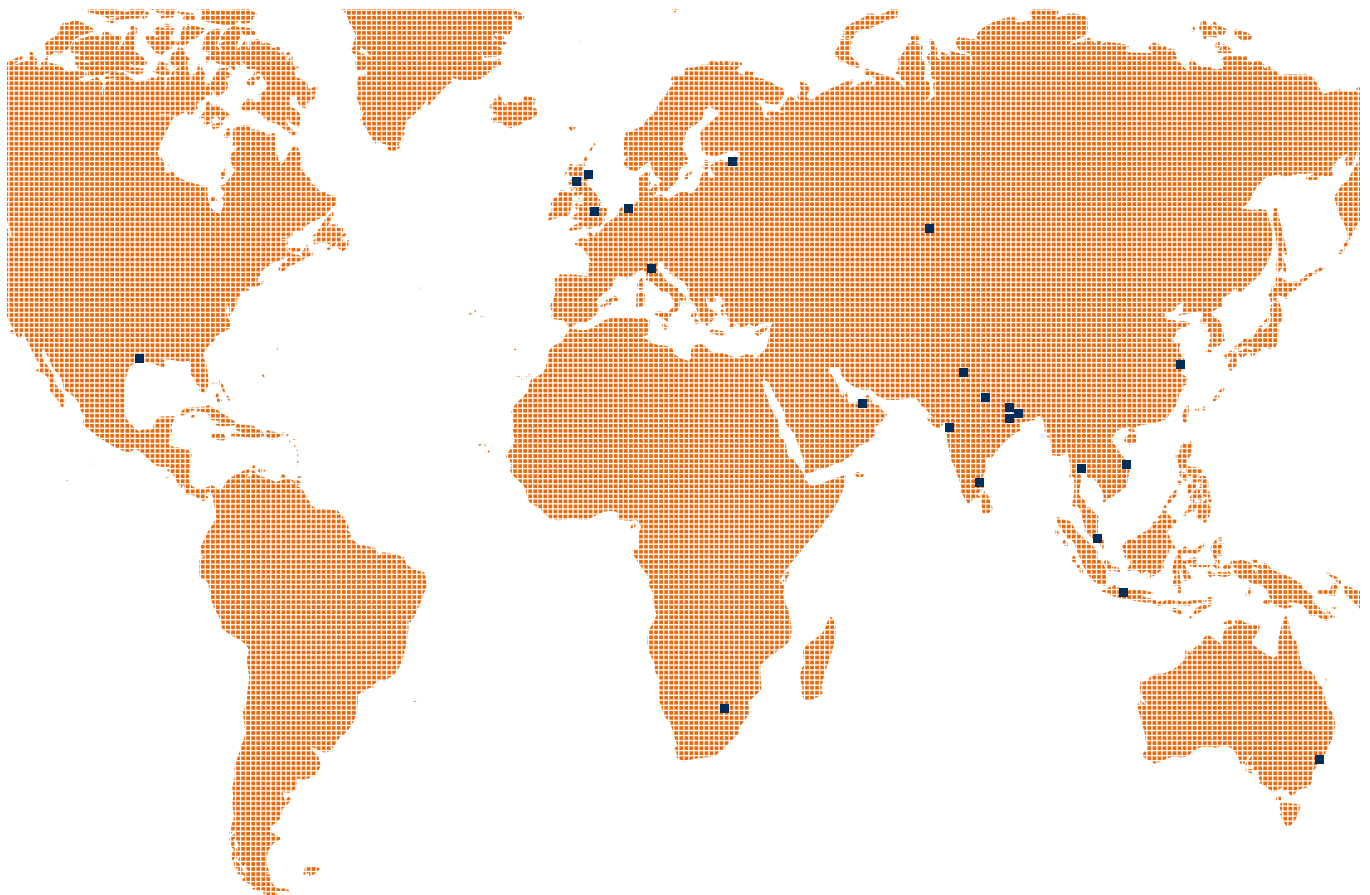

In this world without boundaries, Usha Martin is truly committed to preserve this legacy of quality all over the world and continues to harness its global presence to deliver the best possible solutions for its customers.

WIRE ROPE APPLICATION SELECTOR

Key





-  Recommended
-  Allowed
-  Non recommended

	Grab Unloaders				Rotary Drilling Machines			Tower Cranes			Crawler Cranes	
	Boom	Hoist	Grab closing	Racking	Auxiliary hoist	Pull down	Drilling	Hoist	Trolley	Stay	Boom	Hoist
CRANEMAX XS6K/S6/S8/S6K	✗	✗	✓	✓	✗	✓	✗	✗	✓	✗	✗	✗
CRANEMAX M35K	✗	✗	✗	✗	✓	✗	✓	✓	✗	✗	✗	✓
CRANEMAX M6K	✓	✓	✓	✓	✗	✓	!	✗	✓	✓	✓	✗
CRANEMAX L8K/L10K/XL8K/XL10K	✓	!	✗	✗	✗	!	✗	✗	!	✓	✓	✗
CRANEMAX M10K	✗	!	✗	✗	✗	✗	✗	!	✗	!	✓	!
CRANEMAX XS35/S19K/L24K	✗	✗	✗	✗	!	✗	✗	✓	✗	✗	✗	✓
CRANEMAX XL35K	✗	✗	✗	✗	✓	✗	!	✓	✗	✗	✗	✓
CRANEMAX L8KE/XL10KE	✗	✗	✗	✗	✗	✗	✗	✗	✗	✗	✗	✗

Rope Properties

	Fill factor (f)	MBF factor (k)	Mass factor (k _m) in air	Typical lay type	Modulus (E)*[kN/mm ²]	Torque factor (t)*	Reference lay factor (K _L)	Rotation (R)*[deg/lay]
CRANEMAX XS6K	0.57	0.78	0.0039	Reg	85	0.080	6	70
CRANEMAX S6	0.59	0.83	0.0041	Reg	95	0.080	5.5	70
CRANEMAX S8	0.59	0.81	0.0039	Reg	90	0.012	5.5	120
CRANEMAX S6K	0.66	0.86	0.0045	Reg	100	0.090	5.5	80
CRANEMAX M35K	0.72	0.93	0.0048	Lang	110	0.012	6.5	1
CRANEMAX M6K	0.68	0.92	0.0045	Reg	120	0.075	6.5	60
CRANEMAX L8K	0.69	0.96	0.0047	Reg	120	0.085	6.5	60
CRANEMAX L10K	0.71	0.94	0.0048	Reg	120	0.090	6.75	70
CRANEMAX XL8K	0.74	1.02	0.0049	Reg	130	0.085	6.5	60
CRANEMAX XL10K	0.78	1.02	0.0051	Reg	130	0.100	6.75	90
CRANEMAX XS35	0.60	0.78	0.0040	Lang	105	0.012	6.25	1
CRANEMAX S19K	0.70	0.85	0.0047	Reg	110	0.040	6.25	5
CRANEMAX M10K	0.71	0.93	0.0048	Reg	120	0.045	6.5	4
CRANEMAX L24K	0.70	0.94	0.0046	Lang	120	0.035	6.5	4
CRANEMAX XL35K	0.74	1.00	0.0049	Lang	130	0.012	7	1
CRANEMAX L8KE	0.68	0.98	0.0046	Reg	125	0.085	6.5	60
CRANEMAX XL10KE	0.75	1.05	0.0048	Reg	130	0.100	6.5	90

*Nominal values @ 20% MBF for trained rope

-  Shock resistant
-  Special hoist
-  Rotation & spin resistant
-  Electric hoist

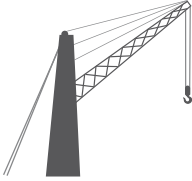
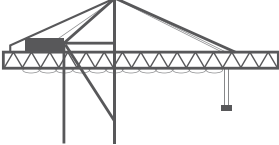
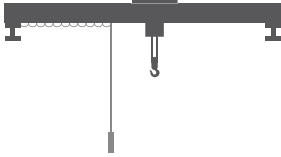
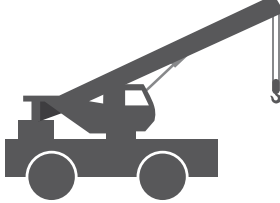
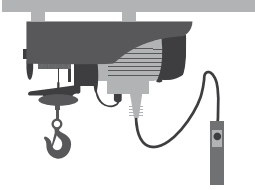
Harbour Cranes			Container Cranes			Overhead & Gantry Launching Cranes	Mobile Cranes	Electric winches
								
Boom	Hoist	Luffing	Boom	Hoist	Trolley	Hoist	Hoist	Hoist
✗	✗	✗	✗	✗	✓	✓	✗	✗
✗	✓	✗	✗	✗	✗	✗	✓	✗
✓	✗	✓	✓	✓	✓	✓	✗	✗
✓	!	✓	✓	✓	!	✓	✗	✗
✓	!	✓	✗	✓	✗	!	!	✗
✗	✓	✗	✗	✗	✗	✗	✓	✗
✗	✓	✗	✗	✗	✗	✗	✓	✗
✗	✗	✗	✗	✗	✗	✗	✗	✓

Rope Calculator

$MBF [kN] = K \cdot d^2$ (d = nominal diameter [mm])

$Mass [kg/m] = k_m \cdot d^2$

$Metallic\ area\ (A) [mm^2] = 0.785 \cdot f \cdot d^2$

$Axial\ stiffness\ (EA) [MN] = E \cdot 0.785 \cdot f \cdot d^2 / 1000$

$Elastic\ elongation\ [\frac{\Delta L}{L}] = Load [kN] / (EA \cdot 1000)$

$Rope\ torque [Nm] = t \cdot d \cdot load [kN]$

Rope Length Available on the Reel

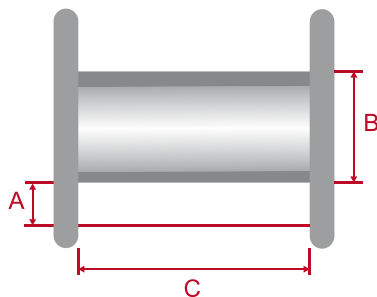

$$L = \frac{\pi \cdot A \cdot C}{d^2} \cdot (A+B)$$

A, B, C [m]

L [m]

d [m]

Maximum Lifting Height for Block Stability

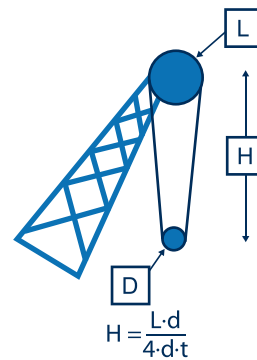

Approximate calculation

In case of number of falls higher than 2

$$H = \frac{L \cdot d}{4 \cdot d \cdot t}$$

$$M = \sqrt{B^2 + D^2}$$

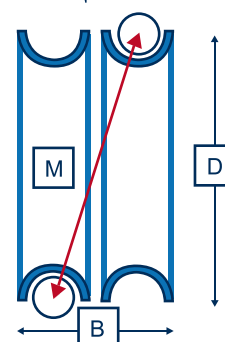

CRANEMAX XS6K

Shock resistant

Diameter		Metallic area		Mass		MBF		
mm	in	mm ²	in ²	kg/m	lb/ft	kN	Tonnes	kips
16	5/8	112	0.173	1.01	0.677	197	20.0	44.2
17		113	0.176	1.02	0.688	200	20.4	44.9
18		128	0.198	1.16	0.777	225	23.0	50.7
19	3/4	144	0.222	1.30	0.871	253	25.8	56.9
20		160	0.248	1.44	0.970	282	28.7	63.4
22		177	0.275	1.60	1.08	312	31.8	70.2
24	7/8	214	0.332	1.94	1.30	378	38.5	85.0
25		219	0.339	1.98	1.33	385	39.3	86.7
26		255	0.395	2.30	1.55	449	45.8	101
28	1	277	0.429	2.50	1.68	488	49.7	110
30		286	0.443	2.58	1.73	503	51.3	113
32		299	0.464	2.70	1.82	527	53.7	119
34	1 1/8	347	0.538	3.14	2.11	612	62.3	138
35		362	0.561	3.27	2.19	637	64.9	143
36		399	0.618	3.60	2.42	702	71.6	158
38	1 1/4	450	0.698	4.03	2.71	786	80.2	177
39		458	0.709	4.10	2.75	799	81.4	180
40		516	0.801	4.62	3.11	902	91.9	203
42	1 3/8	545	0.845	4.88	3.28	951	97.0	214
44		579	0.897	5.18	3.48	1010	103	227
46		645	1.00	5.78	3.88	1130	115	253
48	1 1/2	715	1.11	6.40	4.30	1250	127	281

These figures are for guidance only. Other features, such as MBF, dimensions, lay type and plastic fill can be designed on request. MBF values are referred to 2160 grade, custom values are available on demand.

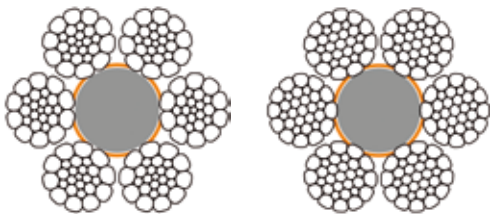

- Excellent shock resistance
- Good resistance to fleet angle
- Improved MBF in respect to conventional hoist ropes



CRANEMAX S6

Shock resistant

Diameter		Metallic area		Mass		MBF		
mm	in	mm ²	in ²	kg/m	lb/ft	kN	Tonnes	kips
16	5/8	117	0.182	1.08	0.728	209	21.3	47.1
		119	0.185	1.10	0.740	212	21.7	47.8
		134	0.208	1.24	0.835	240	24.5	54.0
18	3/4	151	0.234	1.39	0.936	269	27.4	60.5
		168	0.260	1.55	1.04	300	30.5	67.4
		186	0.289	1.72	1.16	332	33.8	74.7
22	7/8	225	0.349	2.08	1.40	402	41.0	90.4
		230	0.356	2.12	1.43	410	41.8	92.3
		268	0.415	2.48	1.66	478	48.7	108
25	1	291	0.451	2.69	1.81	519	52.9	117
		300	0.465	2.77	1.86	535	54.6	120
		315	0.488	2.91	1.95	561	57.2	126
28	1 1/8	365	0.566	3.37	2.27	651	66.3	146
		380	0.589	3.51	2.36	678	69.1	153
		419	0.649	3.87	2.60	747	76.1	168
32	1 1/4	471	0.730	4.33	2.91	837	85.3	188
		478	0.741	4.40	2.96	850	86.6	191

These figures are for guidance only. Other features, such as MBF, dimensions, lay type and plastic fill can be designed on request. MBF values are referred to 2160 grade, custom values are available on demand.

CRANEMAX S8

Shock resistant

Diameter		Metallic area		Mass		MBF		
mm	in	mm ²	in ²	kg/m	lb/ft	kN	Tonnes	kips
20	7/8	186	0.289	1.76	1.18	324	33.0	72.9
22		225	0.349	2.13	1.43	392	40.0	88.2
		230	0.356	2.17	1.46	400	40.8	90.0
24	1	268	0.416	2.53	1.70	467	47.6	105
25		291	0.451	2.75	1.85	506	51.6	114
		300	0.466	2.84	1.91	523	53.3	118
26	1 1/8	315	0.488	2.97	2.00	548	55.8	123
28		365	0.566	3.45	2.32	635	64.7	143
		380	0.589	3.59	2.41	661	67.4	149
30		419	0.649	3.96	2.66	729	74.3	164

These figures are for guidance only. Other features, such as MBF, dimensions, lay type and plastic fill can be designed on request. MBF values are referred to 2160 grade, custom values are available on demand.

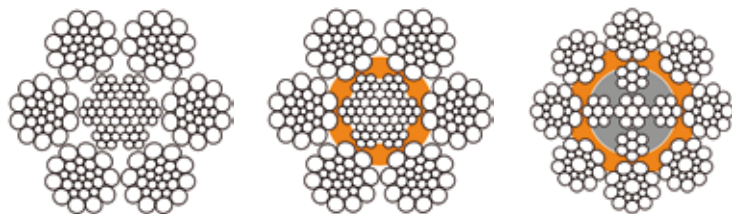

- Excellent shock resistance
- Enhanced resistance to fleet angle if plastic impregnated
- High radial stability with special core construction

CRANEMAX S6K

Shock resistant

Diameter		Metallic area		Mass		MBF		
mm	in	mm ²	in ²	kg/m	lb/ft	kN	Tonnes	kips
16	5/8	129	0.200	1.13	0.762	217	22.1	48.8
17		131	0.203	1.15	0.774	220	22.4	49.5
18		148	0.229	1.30	0.874	249	25.3	55.9
19	3/4	165	0.256	1.46	0.980	279	28.4	62.7
20		184	0.286	1.62	1.09	310	31.6	69.9
22		204	0.317	1.80	1.21	344	35.1	77.4
24	7/8	247	0.383	2.18	1.46	416	42.4	93.7
25		252	0.391	2.22	1.49	425	43.3	95.6
26		294	0.456	2.59	1.74	495	50.5	111
28	1	319	0.495	2.81	1.89	538	54.8	121
30		330	0.511	2.90	1.95	555	56.6	125
32		345	0.535	3.04	2.04	581	59.3	131
30	1 1/8	400	0.621	3.53	2.37	674	68.7	152
32		417	0.646	3.67	2.47	702	71.6	158
34		460	0.712	4.05	2.72	774	78.9	174
36	1 1/4	520	0.805	4.54	3.05	867	88.4	195
38		528	0.818	4.61	3.10	881	89.8	198

These figures are for guidance only. Other features, such as MBF, dimensions, lay type and plastic fill can be designed on request. MBF values are referred to 2160 grade, custom values are available on demand.

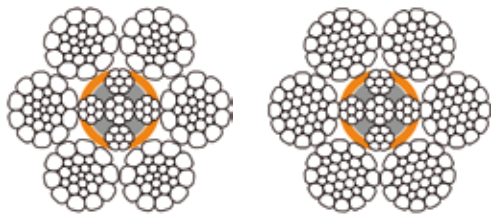

- Excellent shock resistance
- Excellent fleet angle resistance
- High radial stability due to special core construction



CRANEMAX M35K

Shock resistant

Diameter		Metallic area		Mass		MBF		
mm	in	mm ²	in ²	kg/m	lb/ft	kN	Tonnes	kips
16	5/8	143	0.221	1.23	0.830	234	23.9	52.7
17		145	0.224	1.25	0.843	238	24.3	53.6
16		163	0.253	1.42	0.952	269	27.4	60.5
18	3/4	183	0.284	1.59	1.07	301	30.7	67.8
19		204	0.316	1.77	1.19	336	34.2	75.5
20		226	0.351	1.96	1.32	372	37.9	83.7
22	7/8	274	0.424	2.37	1.59	450	45.9	101
23		279	0.433	2.42	1.63	459	46.8	103
24		326	0.505	2.82	1.90	536	54.6	121
25	1	353	0.548	3.06	2.06	581	59.3	131
26		365	0.565	3.16	2.12	600	61.2	135
26		382	0.593	3.31	2.23	629	64.1	141
28	1 1/8	443	0.687	3.84	2.58	729	74.3	164
29		462	0.716	4.00	2.69	759	77.4	171
30		509	0.789	4.41	2.96	837	85.3	188
32	1 1/4	570	0.884	4.94	3.32	937	95.6	211
33		579	0.898	5.02	3.37	952	97.1	214
34	1 1/2	654	1.01	5.66	3.81	1080	110	242
35		690	1.07	5.98	4.02	1130	116	255
36		733	1.14	6.35	4.27	1210	123	271
38	1 1/2	817	1.27	7.08	4.75	1340	137	302
40		905	1.40	7.84	5.27	1490	152	335

These figures are for guidance only. Other features, such as MBF, dimensions, lay type and plastic fill can be designed on request. MBF values are referred to 1960 grade, custom values are available on demand.

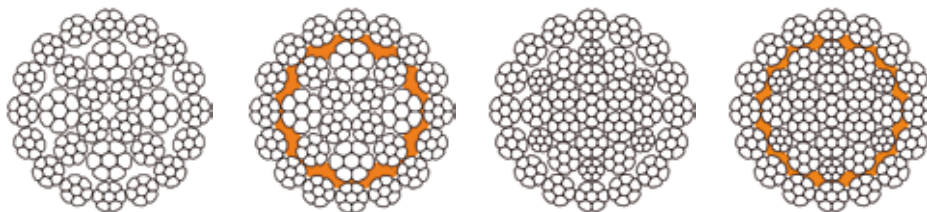

- Good shock resistance
- High radial stiffness and rotational stability
- Enhanced resistance to fleet angle if plastic impregnated



CRANEMAX M6K

Special hoist

Diameter		Metallic area		Mass		MBF		
mm	in	mm ²	in ²	kg/m	lb/ft	kN	Tonnes	kips
10		53.3	0.083	0.460	0.309	92.0	9.38	20.7
11		64.5	0.100	0.557	0.374	111	11.3	25.0
12		76.7	0.119	0.662	0.445	132	13.5	29.8
13	1/2	86.0	0.133	0.742	0.499	148	15.1	33.4
14		90.1	0.140	0.777	0.522	155	15.8	35.0
16	5/8	104	0.162	0.902	0.606	180	18.4	40.6
15		120	0.186	1.04	0.696	207	21.1	46.6
17		134	0.208	1.16	0.779	232	23.6	52.2
18		136	0.211	1.18	0.791	236	24.0	53.0
17		154	0.239	1.33	0.893	266	27.1	59.8
18		173	0.268	1.49	1.00	298	30.4	67.1
19	3/4	192	0.298	1.66	1.12	332	33.9	74.7
20		213	0.330	1.84	1.24	368	37.5	82.8
22		254	0.393	2.23	1.50	445	45.4	100
24	7/8	259	0.401	2.27	1.53	454	46.3	102
24		302	0.468	2.65	1.78	530	54.0	119
25		328	0.508	2.88	1.93	575	58.6	129
26	1	338	0.524	2.97	1.99	594	60.5	134
26		354	0.549	3.11	2.09	622	63.4	140
28		411	0.637	3.61	2.42	721	73.5	162
30	1 1/8	428	0.664	3.76	2.52	751	76.6	169
30		472	0.732	4.14	2.78	828	84.4	186
32	1 1/4	529	0.819	4.54	3.05	927	94.5	209
34		546	0.846	4.61	3.10	932	95.0	210
34		616	0.955	5.20	3.50	1050	107	237
35	1 3/8	650	1.01	5.49	3.69	1110	113	250
36		691	1.07	5.83	3.92	1180	120	265
38	1 1/2	770	1.19	6.50	4.37	1310	134	296
40		853	1.32	7.20	4.84	1460	148	328
41	1 5/8	886	1.37	7.67	5.15	1550	158	349
42		917	1.42	7.94	5.33	1610	164	361
44		1010	1.56	8.71	5.85	1760	180	396
46	1 3/4	1030	1.59	8.89	5.98	1800	183	405
46		1100	1.71	9.52	6.40	1930	196	433
48	1 7/8	1200	1.86	10.4	6.97	2100	214	472
50		1300	2.02	11.3	7.56	2280	232	512
52	2	1340	2.08	11.6	7.80	2350	240	528
54	2 1/8	1410	2.18	12.2	8.18	2460	251	554
54		1520	2.35	13.1	8.82	2650	271	597
56	2 1/4	1630	2.53	14.1	9.48	2850	291	642
58		1750	2.71	15.1	10.2	3060	312	689
60	2 3/8	1890	2.93	16.4	11.0	3310	338	745

These figures are for guidance only. Other features, such as MBF, dimensions, lay type and plastic fill can be designed on request. MBF values are referred to 2160 grade, custom values are available on demand.

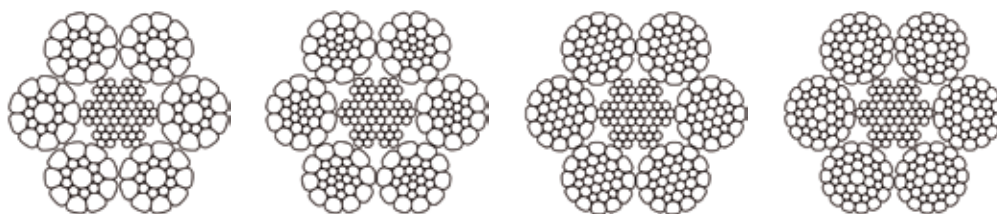

- Improved MBF in respect to conventional hoist ropes
- High dimensional stability
- Good resistance to side pressure and crushing

CRANEMAX L8K

Special hoist

Diameter		Metallic area		Mass		MBF		
mm	in	mm ²	in ²	kg/m	lb/ft	kN	Tonnes	kips
13		92.1	0.143	0.761	0.511	162	16.5	36.5
14		107	0.166	0.882	0.593	188	19.2	42.3
15		123	0.190	1.01	0.680	216	22.0	48.6
16	5/8	137	0.213	1.13	0.762	242	24.7	54.4
17		140	0.216	1.15	0.774	246	25.1	55.3
17		158	0.244	1.30	0.874	277	28.3	62.4
18		177	0.274	1.46	0.980	311	31.7	70.0
19	3/4	197	0.305	1.62	1.09	347	35.3	78.0
20		218	0.338	1.80	1.21	384	39.1	86.4
22		264	0.409	2.18	1.46	465	47.4	105
22	7/8	269	0.417	2.22	1.49	474	48.3	107
24		314	0.487	2.59	1.74	553	56.4	124
25		335	0.520	2.81	1.89	594	60.5	134
25	1	346	0.537	2.90	1.95	613	62.5	138
26		363	0.562	3.04	2.04	642	65.5	145
28		421	0.652	3.53	2.37	745	75.9	168
28	1 1/8	438	0.679	3.67	2.47	776	79.1	175
30		483	0.749	4.05	2.72	855	87.2	192
30	1 1/4	541	0.839	4.54	3.05	958	97.6	215

These figures are for guidance only. Other features, such as MBF, dimensions, lay type and plastic fill can be designed on request. MBF values are referred to 2160 grade, custom values are available on demand.

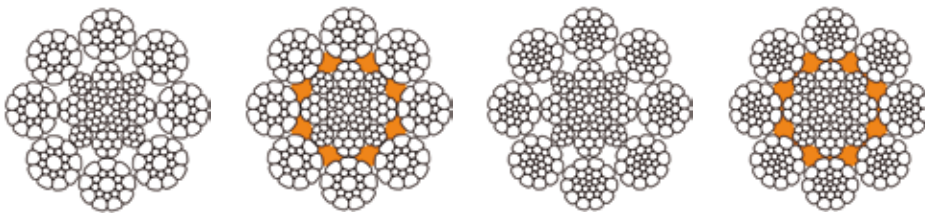

- Smoother contact surface in respect to conventional hoist ropes
- High resistance to side pressure and crushing
- Enhanced resistance to fleet angle if plastic impregnated



CRANEMAX L10K

Special hoist

Diameter		Metallic area		Mass		MBF		
mm	in	mm ²	in ²	kg/m	lb/ft	kN	Tonnes	kips
32		572	0.887	4.61	3.10	963	98.1	217
34		646	1.00	5.20	3.50	1090	111	245
35	1 ³ / ₈	682	1.06	5.49	3.69	1150	117	258
36		724	1.12	5.83	3.92	1220	124	274
38	1 ¹ / ₂	807	1.25	6.50	4.37	1360	138	305
40		894	1.39	7.20	4.84	1500	153	338
41	1 ⁵ / ₈	938	1.45	7.67	5.15	1600	163	360
42		971	1.51	7.94	5.33	1660	169	373
44		1070	1.65	8.71	5.85	1820	186	410
	1 ³ / ₄	1090	1.69	8.89	5.98	1860	189	418
46		1170	1.81	9.52	6.40	1990	203	448
48	1 ⁷ / ₈	1270	1.97	10.4	6.97	2170	221	487
50		1390	2.15	12.0	8.06	2350	240	529
	2	1430	2.22	12.4	8.32	2430	247	546
52		1500	2.33	13.0	8.72	2540	259	572
54	2 ¹ / ₈	1620	2.51	14.0	9.41	2710	276	610
56		1740	2.70	15.1	10.1	2920	297	656
58	2 ¹ / ₄	1870	2.89	16.2	10.9	3130	319	704
60	2 ³ / ₈	2020	3.13	17.5	11.7	3380	345	762

These figures are for guidance only. Other features, such as MBF, dimensions, lay type and plastic fill can be designed on request. MBF values are referred to 2160 grade, custom values are available on demand.

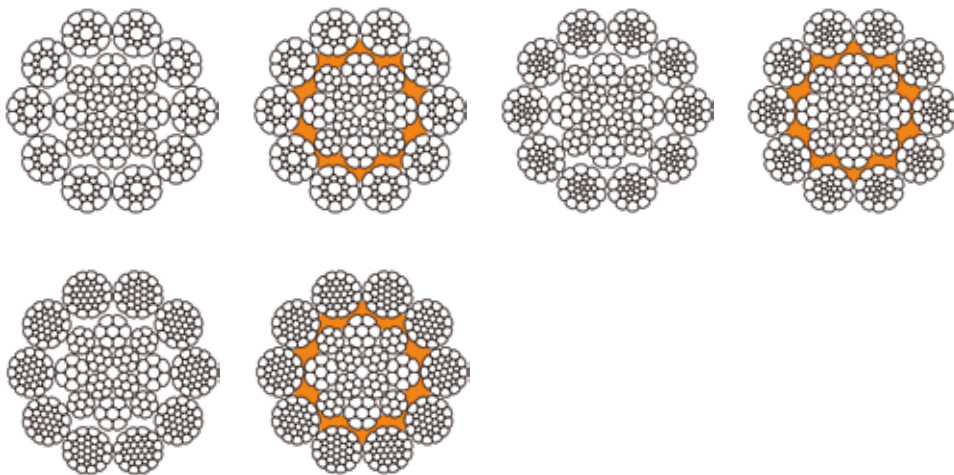

- Enhanced radial stiffness and diameter stability
- High resistance to side pressure and crushing
- Enhanced resistance to fleet angle if plastic impregnated

CRANEMAX XL8K

Special hoist

Diameter		Metallic area		Mass		MBF		
mm	in	mm ²	in ²	kg/m	lb/ft	kN	Tonnes	kips
10		57.7	0.089	0.490	0.329	102	10.4	23.0
11		69.8	0.108	0.593	0.398	123	12.6	27.8
12		83.1	0.129	0.706	0.474	147	15.0	33.1
13	1/2	93.1	0.144	0.790	0.531	165	16.8	37.0
14		97.5	0.151	0.828	0.556	172	17.6	38.8
14		113	0.175	0.960	0.645	200	20.4	45.0
15	5/8	130	0.201	1.10	0.741	230	23.4	51.6
16		145	0.225	1.23	0.830	257	26.2	57.8
16		148	0.229	1.25	0.843	261	26.6	58.8
17		167	0.259	1.42	0.952	295	30.0	66.3
18		187	0.290	1.59	1.07	331	33.7	74.4
19	3/4	208	0.323	1.77	1.19	368	37.5	82.9
20		231	0.358	1.96	1.32	408	41.6	91.8
22	7/8	279	0.433	2.37	1.59	494	50.3	111
22		285	0.442	2.42	1.63	504	51.4	113
24		332	0.515	2.82	1.90	588	59.9	132
25	1	364	0.564	3.06	2.06	638	65.0	143
25		375	0.582	3.16	2.12	658	67.1	148
26		393	0.610	3.31	2.23	690	70.3	155
28	1 1/8	456	0.707	3.84	2.58	800	81.5	180
28		475	0.736	4.00	2.69	833	84.9	187
30	1 1/4	524	0.812	4.41	2.96	918	93.6	207
30		586	0.909	4.94	3.32	1030	105	231

These figures are for guidance only. Other features, such as MBF, dimensions, lay type and plastic fill can be designed on request. MBF values are referred to 2160 grade, custom values are available on demand.

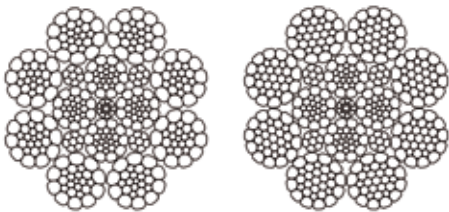

- Extremely high MBF
- Enhanced radial stiffness and diameter stability
- High resistance to side pressure and crushing



CRANEMAX XL10K

Special hoist

Diameter		Metallic area		Mass		MBF		
mm	in	mm ²	in ²	kg/m	lb/ft	kN	Tonnes	kips
32		627	0.971	5.12	3.44	1040	107	235
34		707	1.10	5.78	3.88	1180	120	265
35	1 ³ / ₈	746	1.16	6.10	4.10	1240	127	280
36		793	1.23	6.48	4.36	1320	135	297
38	1 ¹ / ₂	884	1.37	7.22	4.85	1470	150	331
40		979	1.52	8.00	5.38	1630	166	367
41		1030	1.59	8.52	5.72	1740	177	391
42		1070	1.65	8.82	5.93	1800	183	405
44		1170	1.81	9.68	6.51	1970	201	444
46	1 ³ / ₄	1190	1.85	9.88	6.64	2020	205	454
48	1 ⁷ / ₈	1280	1.98	10.6	7.11	2160	220	486
		1390	2.16	11.5	7.74	2350	240	529
50		1510	2.34	12.5	8.40	2550	260	574
	2	1560	2.41	12.9	8.67	2630	268	592
52		1630	2.53	13.5	9.09	2730	278	615
54	2 ¹ / ₈	1760	2.73	14.6	9.80	2920	297	656
56		1890	2.93	15.7	10.5	3140	320	706
58	2 ¹ / ₄	2030	3.15	16.8	11.3	3330	339	749
60	2 ³ / ₈	2200	3.41	18.2	12.2	3600	367	811

These figures are for guidance only. Other features, such as MBF, dimensions, lay type and plastic fill can be designed on request. MBF values are referred to 2160 grade, custom values are available on demand.

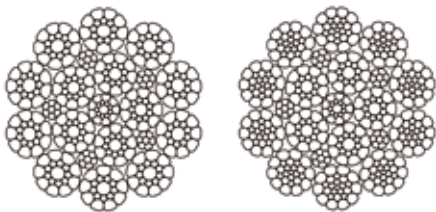

- Extremely high MBF and E modulus
- Enhanced radial stiffness and diameter stability
- High resistance to side pressure and crushing



Diameter		Metallic area		Mass		MBF		
mm	in	mm ²	in ²	kg/m	lb/ft	kN	Tonnes	kips
10		47.2	0.073	0.410	0.276	78.0	7.95	17.6
11		57.1	0.089	0.496	0.333	94.4	9.62	21.2
12		68.0	0.105	0.590	0.397	112	11.4	25.3
13	1/2	76.2	0.118	0.661	0.444	126	12.8	28.3
14		79.8	0.124	0.693	0.466	132	13.4	29.7
		92.6	0.143	0.804	0.540	153	15.6	34.4
15	5/8	106	0.165	0.923	0.620	176	17.9	39.5
		119	0.184	1.03	0.694	197	20.0	44.2
16		121	0.187	1.05	0.705	200	20.4	44.9
17		136	0.212	1.18	0.796	225	23.0	50.7
18		153	0.237	1.33	0.890	253	25.8	56.9
19	3/4	170	0.264	1.48	0.990	282	28.7	63.4
20		189	0.292	1.64	1.10	312	31.8	70.2
22	7/8	228	0.354	1.98	1.33	378	38.5	85.0
		233	0.361	2.03	1.36	385	39.3	87.0
24		272	0.421	2.36	1.59	449	45.8	101
25		295	0.457	2.56	1.72	488	49.7	110
	1	304	0.472	2.65	1.78	503	51.3	113
26		319	0.494	2.77	1.86	527	53.7	119
28	1 1/8	370	0.573	3.21	2.16	612	62.3	138
		385	0.597	3.35	2.25	637	64.9	143
30	1 1/4	424	0.658	3.69	2.48	702	71.6	158
		475	0.737	4.13	2.78	786	80.2	177
32		483	0.748	4.20	2.82	799	81.4	180

These figures are for guidance only. Other features, such as MBF, dimensions, lay type and plastic fill can be designed on request. MBF values are referred to 2160 grade, custom values are available on demand.

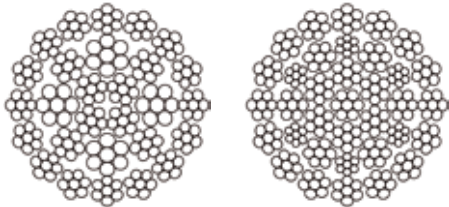

- Excellent rotational properties
- High flexibility and handling properties
- High resistance to side pressure and crushing



CRANEMAX S19K

Rotation resistant

Diameter		Metallic area		Mass		MBF		
mm	in	mm ²	in ²	kg/m	lb/ft	kN	Tonnes	kips
17		159	0.247	1.30	0.874	246	25.0	55.3
18		178	0.276	1.46	0.980	275	28.1	62.0
19	3/4	199	0.308	1.62	1.09	307	31.3	69.0
20		220	0.341	1.80	1.21	340	34.7	76.5
22	7/8	266	0.413	2.18	1.46	411	41.9	92.6
		272	0.421	2.22	1.49	420	42.8	94.5
24		317	0.491	2.59	1.74	490	49.9	110
25	1	344	0.533	2.81	1.89	531	54.2	120
		355	0.550	2.90	1.95	548	55.9	123
26		372	0.577	3.04	2.04	575	58.6	129
28	1 1/8	432	0.669	3.53	2.37	666	67.9	150
		449	0.697	3.67	2.47	694	70.7	156
30	1 1/4	495	0.768	4.05	2.72	765	78.0	172
		555	0.860	4.54	3.05	857	87.3	193
32		564	0.874	4.61	3.10	870	88.7	196

These figures are for guidance only. Other features, such as MBF, dimensions, lay type and plastic fill can be designed on request. MBF values are referred to 2160 grade, custom values are available on demand.

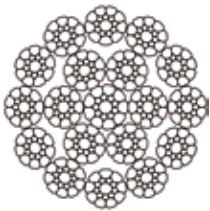

- Good rotational stability
- Good radial stiffness and diameter stability
- Good resistance to side pressure and crushing



CRANEMAX M10K

Spin resistant

Diameter		Metallic area		Mass		MBF		
mm	in	mm ²	in ²	kg/m	lb/ft	kN	Tonnes	kips
10		55.3	0.086	0.480	0.323	93.0	9.50	20.9
11		67.0	0.104	0.581	0.390	113	11.5	25.3
12		79.7	0.124	0.691	0.464	134	13.7	30.1
13	1/2	89.3	0.138	0.774	0.520	150	15.3	33.8
14		93.5	0.145	0.811	0.545	157	16.0	35.4
14		108	0.168	0.941	0.632	182	18.6	41.0
15	5/8	125	0.193	1.08	0.726	209	21.3	47.1
16		139	0.216	1.21	0.813	234	23.9	52.7
16		142	0.220	1.23	0.826	238	24.3	53.6
17		160	0.248	1.39	0.932	269	27.4	60.5
18		179	0.278	1.56	1.05	301	30.7	67.8
19	3/4	200	0.310	1.73	1.16	336	34.2	75.5
20		221	0.343	1.92	1.29	372	37.9	83.7
22	7/8	268	0.415	2.32	1.56	450	45.9	101
22		273	0.424	2.37	1.59	459	46.8	103
24		319	0.494	2.76	1.86	536	54.6	121
25		341	0.528	3.00	2.02	575	58.6	129
25	1	352	0.545	3.10	2.08	594	60.5	134
26		368	0.571	3.24	2.18	622	63.4	140
28	1 1/8	427	0.662	3.76	2.53	721	73.5	162
28		445	0.690	3.92	2.63	751	76.6	169
30	1 1/4	491	0.760	4.32	2.90	828	84.4	186
32		549	0.852	4.84	3.25	927	94.5	209
32		558	0.865	4.92	3.30	942	96.0	212
34		630	0.977	5.55	3.73	1060	108	239
35	1 3/8	665	1.03	5.85	3.93	1120	114	253
36		706	1.10	6.22	4.18	1190	122	268
38	1 1/2	787	1.22	6.93	4.66	1330	135	299
40		872	1.35	7.68	5.16	1470	150	331
41	1 5/8	929	1.44	8.18	5.50	1570	160	353
42		961	1.49	8.47	5.69	1620	165	365
44	1 3/4	1060	1.64	9.29	6.24	1780	182	401
44		1080	1.67	9.48	6.37	1820	185	409
46		1150	1.79	10.2	6.83	1950	198	438
48	1 7/8	1260	1.95	11.1	7.43	2120	216	477
50		1360	2.11	12.0	8.06	2300	234	518

These figures are for guidance only. Other features, such as MBF, dimensions, lay type and plastic fill can be designed on request. MBF values are referred to 2160 grade, custom values are available on demand.

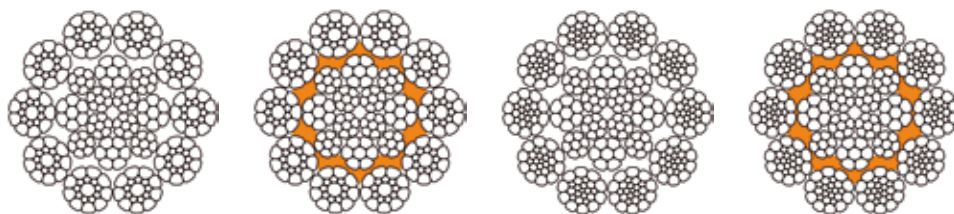

- Lower torque factor in respect to traditional hoist ropes
- Enhanced resistance to fleet angle if plastic impregnated
- High resistance to side pressure and crushing

CRANEMAX L24K

Rotation resistant

Diameter		Metallic area		Mass		MBF		
mm	in	mm ²	in ²	kg/m	lb/ft	kN	Tonnes	kips
6		19.8	0.031	0.169	0.114	33.8	3.45	7.61
7		27.0	0.042	0.230	0.155	46.1	4.70	10.4
8	5/16	35.2	0.055	0.301	0.202	60.2	6.13	13.5
9		44.6	0.069	0.381	0.256	76.1	7.76	17.1
	3/8	49.9	0.077	0.426	0.287	85.3	8.69	19.2
10		55.0	0.085	0.470	0.316	94.0	9.58	21.2
11		66.6	0.103	0.569	0.382	114	11.6	25.6
12		79.2	0.123	0.677	0.455	135	13.8	30.5
	1/2	88.7	0.138	0.758	0.509	152	15.5	34.1
13		93.0	0.144	0.794	0.534	159	16.2	35.7
14		108	0.167	0.921	0.619	184	18.8	41.5
15		124	0.192	1.06	0.711	212	21.6	47.6
	5/8	139	0.215	1.18	0.796	237	24.1	53.3
16		141	0.218	1.20	0.809	241	24.5	54.2
17		159	0.246	1.36	0.913	272	27.7	61.1
18		178	0.276	1.52	1.02	305	31.0	68.5
19	3/4	199	0.308	1.70	1.14	339	34.6	76.4
20		220	0.341	1.88	1.26	376	38.3	84.6
	7/8	266	0.413	2.27	1.53	455	46.4	102
		272	0.421	2.32	1.56	464	47.3	104
24		317	0.491	2.71	1.82	541	55.2	122

These figures are for guidance only. Other features, such as MBF, dimensions, lay type and plastic fill can be designed on request. MBF values are referred to 2160 grade, custom values are available on demand.

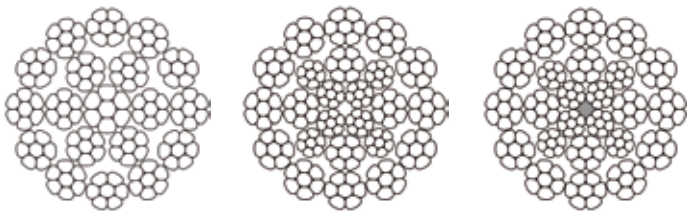

- High rotational stability
- Good radial stiffness and diameter stability
- High resistance to side pressure and crushing



Diameter		Metallic area		Mass		MBF		
mm	in	mm ²	in ²	kg/m	lb/ft	kN	Tonnes	kips
10		56.0	0.087	0.490	0.329	100	10.2	22.5
11		67.8	0.105	0.593	0.398	121	12.3	27.2
12		80.6	0.125	0.706	0.474	144	14.7	32.4
13	1/2	90.3	0.140	0.790	0.531	161	16.4	36.3
14		94.6	0.147	0.828	0.556	169	17.2	38.0
14		110	0.170	0.960	0.645	196	20.0	44.1
15	5/8	126	0.195	1.10	0.741	225	22.9	50.6
16		141	0.219	1.23	0.830	252	25.7	56.7
16		143	0.222	1.25	0.843	256	26.1	57.6
17		162	0.251	1.42	0.952	289	29.5	65.0
18		181	0.281	1.59	1.07	324	33.0	72.9
19	3/4	210	0.326	1.81	1.21	361	36.8	81.2
20		233	0.361	2.00	1.34	400	40.8	90.0
22	7/8	282	0.437	2.42	1.63	484	49.3	109
22		288	0.446	2.47	1.66	494	50.4	111
24		336	0.520	2.88	1.94	576	58.7	130
25		364	0.564	3.13	2.10	625	63.7	141
25	1	376	0.582	3.23	2.17	645	65.8	145
26		394	0.610	3.38	2.27	676	68.9	152
28	1 1/8	457	0.708	3.92	2.63	784	79.9	176
28		476	0.737	4.08	2.74	817	83.2	184
30	1 1/4	524	0.813	4.50	3.02	900	91.7	203
32		587	0.910	5.04	3.39	1010	103	227
32		596	0.925	5.12	3.44	1020	104	230
34		673	1.04	5.78	3.88	1160	118	260
35	1 3/8	710	1.10	6.10	4.10	1220	124	274
36		755	1.17	6.48	4.36	1300	132	292
38	1 1/2	841	1.30	7.22	4.85	1440	147	325
40		932	1.44	8.00	5.38	1600	163	360

These figures are for guidance only. Other features, such as MBF, dimensions, lay type and plastic fill can be designed on request. MBF values are referred to 2160 grade, custom values are available on demand.

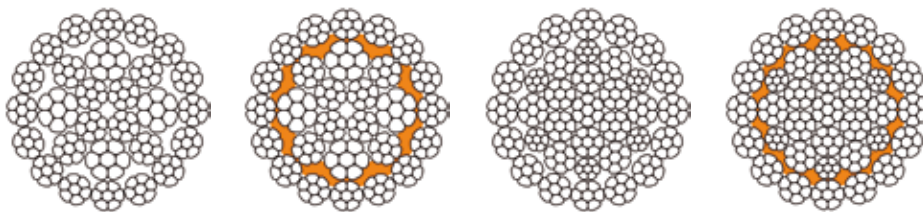

- Excellent rotational properties
- Extremely high MBF
- Enhanced resistance to fleet angle if plastic impregnated

CRANEMAX L8KE

Electric hoist

Diameter		Metallic area		Mass		MBF		
mm	in	mm ²	in ²	kg/m	lb/ft	kN	Tonnes	kips
6		19.2	0.030	0.158	0.106	35.3	3.60	7.94
7		26.1	0.040	0.216	0.145	48.0	4.90	10.8
8	5/16	34.1	0.053	0.282	0.189	62.7	6.39	14.1
9		43.1	0.067	0.356	0.240	79.4	8.09	17.9
10	3/8	48.3	0.075	0.399	0.268	88.9	9.06	20.0
11		53.3	0.083	0.440	0.296	98.0	10.0	22.1
12		64.7	0.100	0.545	0.366	116	11.8	26.1
13		77.0	0.119	0.648	0.435	138	14.1	31.1
14	1/2	86.3	0.134	0.726	0.488	155	15.8	34.8
15		90.4	0.140	0.761	0.511	162	16.5	36.5
16		105	0.163	0.882	0.593	188	19.2	42.3
17		120	0.187	1.01	0.680	216	22.0	48.6
18	5/8	135	0.209	1.13	0.762	242	24.7	54.4
19		137	0.213	1.15	0.774	246	25.1	55.3
20		155	0.240	1.30	0.874	277	28.3	62.4
21		174	0.269	1.46	0.980	311	31.7	70.0

These figures are for guidance only. Other features, such as MBF, dimensions, lay type and plastic fill can be designed on request. MBF values are referred to 2160 grade, custom values are available on demand.

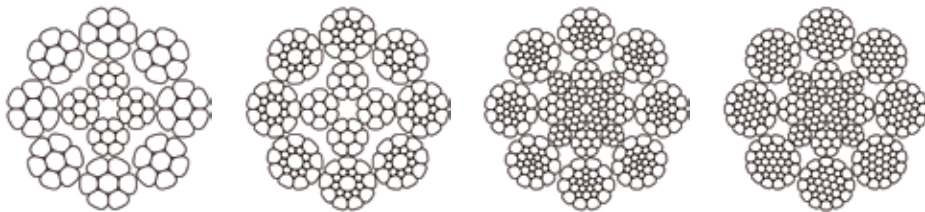

- Specifically designed for electric winches
- High flexibility and handling properties

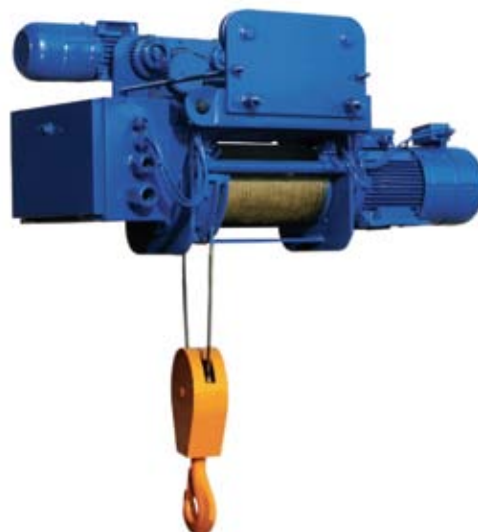

CRANEMAX XL10KE

Electric hoist

Diameter		Metallic area		Mass		MBF		
mm	in	mm ²	in ²	kg/m	lb/ft	kN	Tonnes	kips
6		21.1	0.033	0.173	0.116	37.8	3.85	8.51
7		28.7	0.045	0.235	0.158	51.5	5.24	11.6
	5/16	37.5	0.058	0.307	0.206	67.2	6.85	15.1
9		47.5	0.074	0.389	0.261	85.1	8.67	19.1
	3/8	53.2	0.082	0.435	0.293	95.3	9.71	21.4
10		58.7	0.091	0.480	0.323	105	10.7	23.6
11		71.0	0.110	0.581	0.390	125	12.7	28.0
12		84.5	0.131	0.691	0.464	148	15.1	33.4
	1/2	94.6	0.147	0.774	0.520	166	16.9	37.4
13		99.1	0.154	0.811	0.545	174	17.7	39.2
14		115	0.178	0.941	0.632	202	20.6	45.4
15		132	0.205	1.08	0.726	232	23.6	52.1
	5/8	148	0.229	1.21	0.813	260	26.5	58.4
16		150	0.233	1.23	0.826	264	26.9	59.3
17		170	0.263	1.39	0.932	298	30.3	67.0
18		190	0.295	1.56	1.05	334	34.0	75.1

These figures are for guidance only. Other features, such as MBF, dimensions, lay type and plastic fill can be designed on request. MBF values are referred to 2160 grade, custom values are available on demand.

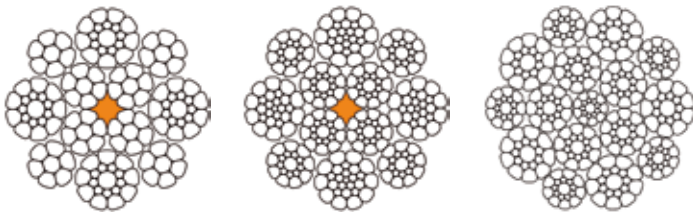

- Specifically designed for electric winches
- Extremely high MBF
- High flexibility and handling properties



Each rope is first of all characterized by its nominal diameter, from which the actual diameter is estimated depending on regulations, application type and specific customer requests.

The actual diameter of wire rope changes during use due to initial rope stabilization, the effect of working tension, and wear caused by passage over components of the reeving system.

To ensure good rope performance when operating on grooved drums, the actual diameter has to comply with the oversize of the groove. Recommended diameter tolerance is +2% / +4%. This value is very common for hoisting applications, and will be the reference value for the information contained in this catalogue, however it can be adapted on the basis of specific customer requirements.

Lay direction is selected to confer unique characteristics to the product: when spooled over drums, Lang's lay ropes ensure better stability to side wear (a phenomenon also known as "crushing") as the contacts between the wires of rope wraps are smoother than in regular lay construction. On the other hand, regular lay improves rotation stability and therefore can give other beneficial effects.

Lay length is also selected in accordance with specific requirements: longer lay improves load capacity, Young modulus and consequently axial stiffness, whereas shorter lay gives better resistance to shock loading.

Ropes for special hoisting require a high load efficiency and are typically composed of compacted strands, obtained by means of dies or roller devices during manufacture.

High compacting level allows an improvement in the metallic area of up to 15% in respect to conventional strands, and also leads to smoother surface contact, dimensional stability in respect to side pressure, resistance to wear and abrasion, and better spooling capacity.

In case of reeving arrangements involving a relatively high fleet angle between adjacent components (from 2° to 4°), plastic impregnated core ropes can be adopted to enhance rope stability.

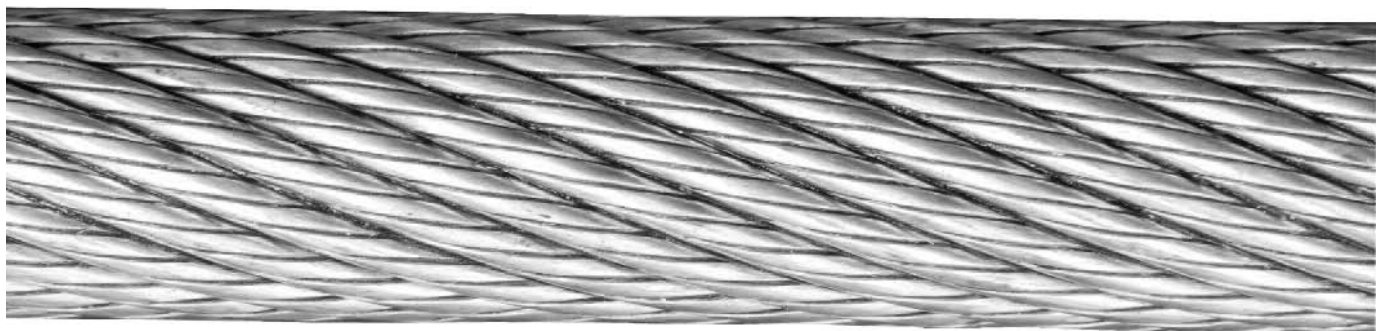

Definitions

Lay direction:	The direction right (Z or RH) or left (S or LH) corresponding to the direction of lay of the outer strands in a stranded rope in relation to the longitudinal axis of the rope.
Ordinary lay (or regular):	Stranded rope in which the direction of lay of the wires in the outer strands is in the opposite direction to the lay of the outer strands in the rope (RL).
Lang lay:	Stranded rope in which the lay direction of the wires in the outer strands is in the same lay direction as that of the outer strands in the rope (LL).
Rope lay length (H):	That distance (H) parallel to the longitudinal rope axis in which the outer wires of a spiral rope, the outer strands of a stranded rope or the unit ropes of a cable-laid rope make one complete turn (or helix) about the axis of the rope.

A fundamental requirement for wire rope is achievement of the minimum breaking force that complies with the crane or winch safe working load.

Rope breaking force can be seen as a function of metallic area, strength and spinning factor. These elements must be carefully combined to confer reliable mechanical properties.

Metallic area depends on the rope's geometrical construction, diameter oversize and compacting level; strength is dependent on the characteristics of the wire; and spinning factor is dependent on manufacturing skill, geometrical construction and compacting level.

However, it must be emphasised that a high breaking force in itself is not sufficient to ensure safe working conditions.

These can be achieved if it is possible to detect within an acceptable time scale that the rope is approaching the end of its useful life or that the prescribed payload has been exceeded.

Good quality ropes must be composed of ductile wires, which will break gradually following remarkable plastic deformation. This gradual breakage will be clearly noticeable by a competent person with responsibility for rope integrity management.

Ropes that rely solely on the use of extremely high strength wires for their breaking force can have severe implications in terms of safety, as the wires will have the tendency to break suddenly without giving proper notice of arising problems.

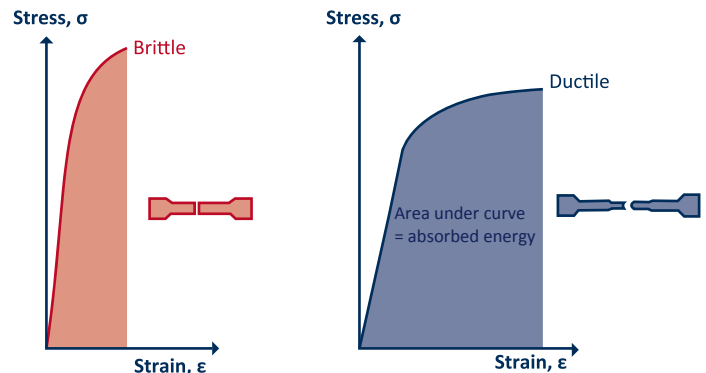

The graph above compares the behaviour of wires with different strengths: the red line represents a brittle trend typical of high strength steel (over 2160 N/mm²). The blue line represents the typical trend of lower strength steel (1770 and 1960 N/mm²).

It is therefore essential to adopt the minimum possible strength level and to achieve the desired breaking force by a combination of high compacting level, finely tuned geometrical construction and manufacturing reliability.

Definitions

Metallic cross-section (A):	The product of the nominal metallic cross-sectional area factor (C) and the square of the nominal rope diameter.
Fill factor (f):	The ratio between the sum of the nominal metallic cross-sectional areas of all the wires in the rope and the circumscribed area of the rope based on its nominal diameter (d).
Rope grade:	A level of requirement of breaking force which is designated by a number (e.g. 1770, 1960). NOTE - it does not imply that the actual tensile strength grades of the wires in the rope are necessarily of this grade.
Wire tensile strength grade:	A level of requirement of tensile strength of a wire and its corresponding range. It is designated by the value according to the lower limit of tensile strength and is used when specifying wire and when determining the calculated minimum breaking force or calculated minimum aggregate breaking force of a rope, expressed in N/mm ² .
Tensile strength:	The ratio between the maximum force obtained in a tensile test and the nominal cross-sectional area of the test piece, expressed in N/mm ² .

Correct selection of raw material is essential in order to achieve the required breaking force and mechanical characteristics.

Our wire ropes are manufactured using a high carbon content, patented rod, which allows to achieve high rope grades without the adoption of extreme wire strength.

The rod is subjected to a drawing process, which consists of a number of passages through a series of tungsten carbide dies with a gradual diameter reduction. During this process, the metallurgical structure of the rod changes from a very thin perlite pattern to well aligned fibres with high tenacity and strength.

The selection of carbon content and amount of drawing is determined depending on the specific application of the wire rope and the required mechanical characteristics.

Steel has to be protected against corrosion and consequently zinc coating is highly recommended for the marine environment.

The quantity of zinc which has to be applied to wires is regulated by EN 10264 - steel wire and wire products - steel wire for ropes.

For rope used in industrial applications, the typical zinc thickness is approximately 10 to 20 microns, which complies with class B.

Zinc is applied on the wire rod by a hot dip process in order to avoid hydrogen embrittlement typical of electrochemical plating. Hot dip galvanizing creates a tight connection between zinc and steel, virtually alloying them in one unique entity.



For severe environmental conditions, improved surface finishing based on zinc aluminium alloys can also be adopted.

It must be emphasised that surface finishing has to be adopted in conjunction with adequate lubrication and maintenance levels in order to preserve wire rope performance.

Storage of the rope in very warm or humid conditions should be avoided as this could break down the effectiveness of native lubrication and accelerate the deterioration process.

Wire ropes are lubricated during manufacture in accordance with application type and customer specification. This lubrication will be long-lasting if the rope is properly stored.

Rope integrity management should be undertaken by properly trained personnel, with reference to applicable codes, standards and regulations for handling and inspection requirements.

Lubrication condition should be verified on a regular basis and before rope installation, to detect possible grease anomalies. In case of doubt, rope should be cleaned from surface contaminants and properly relubricated.

Below is an example of safety label currently adopted by wire rope manufacturers.

In order to ensure maximum performance during operations, in general rope for special applications are not fully preformed during manufacturing, therefore proper serving is essential to avoid strand unlaying and safety issues.

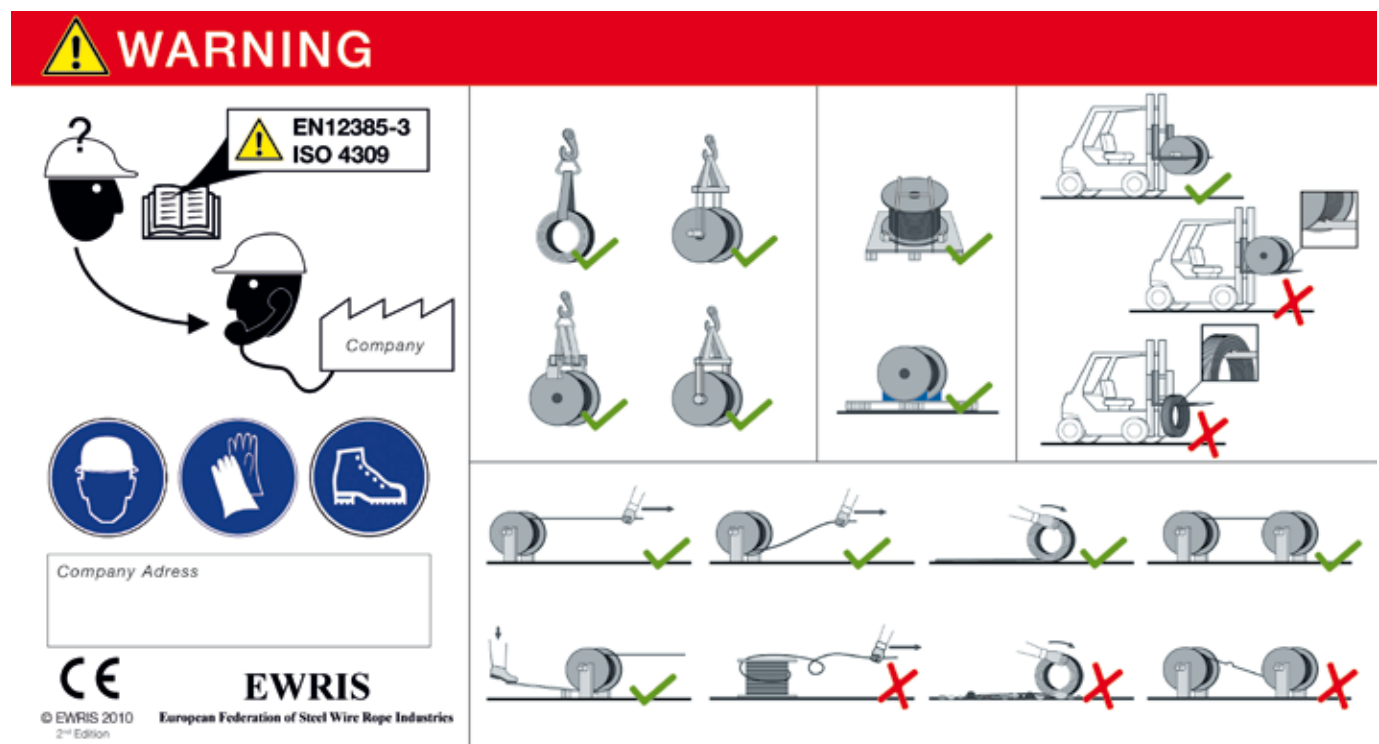

Definitions

- Fully performed rope:** Rope in which the wires in the strands and strands in the rope have their internal stresses reduced, resulting in a rope in which, after removal of any serving, the wires and the strands will not spring out of the rope formation.
- Serving:** Wrapping, usually made of wire or strand, for the purpose of securing a rope end to prevent its unlaying.
- Permanent serving:** Serving applied prior to socketing and remaining in place at least until the socketing operation has been completed.
- Temporary serving:** Serving applied and subsequently removed at various stages of the socketing operation.
- Competent person:** Designated person, suitably trained, qualified by knowledge and experience and with the necessary instructions to ensure that the required operations are correctly carried out.

Unless otherwise agreed with the customer, ropes are provided on reels which are designed for the purpose of transportation and storage.

The direction of rope lay should be chosen in accordance to drum direction following the general rule “right hand pitch – left hand rope”, see image below. However this is often not applicable to heavy lifting devices, which usually requires the use of large size multilayer drums.

In this case, there are no special requirements and lay direction can be selected to facilitate the drum bedding, or optimized taking into account the rope layer that will be more frequently used during operations.

In order to ensure expected lifespan and performance, it is essential to have a tight bedding on the first winch drum layer, which is achieved by applying the correct installation tension. It should be at least the highest value between 2% of the rope MBF or 10% of rope SWL.

Training is essential for any rope size to optimize rope lifetime and performance, as well as to stabilize its dimensions.

It involves the unwinding of the full rope length, excluding the safety wraps, which must always remain on the drum, at least three times with any available payload: the weight of the rope will automatically generate diameter stabilization and torque factor reduction.

Safety wraps should be clearly identified to prevent unnoticed use.

A good spooling will show tight wraps and uniform rope arrangement in the cross over zone and up the last layers. This will reduce the risk of crushing, cut-in or early formation of broken wires.

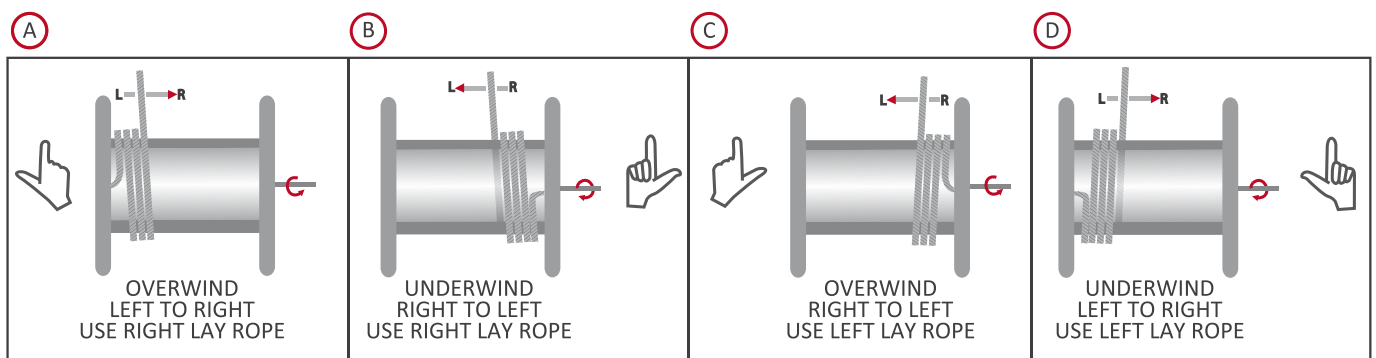

Definitions

WLL/SWL:	Working Load Limit/Safe Working Load. WLL is the ultimate permissible load, assigned by the manufacturer of the item (crane). The SWL may be the same as the WLL but may be a lower value assigned by an independent competent person taking account of particular service conditions.
Working length:	Working length is the portion of total length plus three wraps that has been used in operations since the last thorough examination.
Wraps/layers:	A wrap is a single turn of a wire rope around the circumference of a drum. A layer is a number of wraps covering the horizontal distance between the drum flanges.
Cross-over zone:	That portion of rope coincident with a crossing over of one wrap by another as the rope traverses the drum or rises from one layer to the next at the drum flange.

TYPICAL ROPE DAMAGE



Wire protrusion

Cause Improper rope handling
Ref. ISO4309 - 6.6.5
Action Discard [can be removed for limited extension]



Core protrusion

Cause Fleet angle, shock loading
Ref. ISO4309 - 6.6.4
Action Immediate discard



Protrusion of inner rope

Cause Fleet angle, shock loading
Ref. ISO4309 - E.4 c)
Action Immediate discard



Strand protrusion or distortion

Cause Forced twist
Ref. ISO4309 - 6.6.4
Action Immediate discard



Local increase in rope diameter

Cause Fleet angle
Ref. ISO4309 - 6.6.6
Action Remove the cause and monitor the evolution



Local reduction in diameter

Cause Core break
Ref. ISO4309 - 6.3
Action Immediate discard



Kink (positive)

Cause Fleet angle, forced rotation
Ref. ISO4309 - 6.6.8
Action Immediate discard



Kink (negative)

Cause Fleet angle, forced rotation
Ref. ISO4309 - 6.6.8
Action Immediate discard

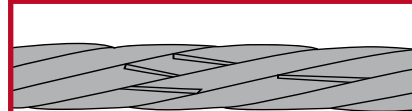

Valley wire breaks

Cause Fatigue and improper rope design
Ref. ISO4309 - 6.2
Action Discard [can be removed for limited extension]

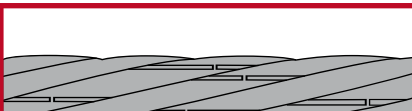

Crown wire breaks

Cause Fatigue
Ref. ISO4309 - 6.2
Action Discard [can be removed for limited extension]



Flattened portion

Cause Rope derailing over the sheave
Ref. ISO4309 - 6.6.7
Action Immediate discard



External wear

Cause Normal use
Ref. ISO4309 - 5.3.1, E2
Action Keep monitored

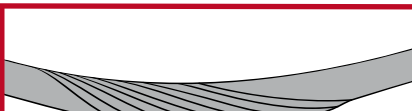

Basket deformation (birdcage)

Cause Improper installation, narrow grooves
Ref. ISO4309 - 6.6.3
Action Immediate discard

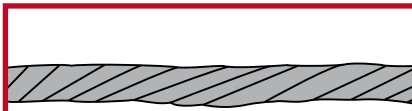

Waviness

Cause Reverse bending, rope rotation
Ref. ISO4309 - 6.6.2
Action Keep monitored



External corrosion

Cause Environment conditions
Ref. ISO4309 - 6.5
Action Keep monitored

The following list includes the main reference documents for crane wire ropes. The list is not exhaustive, as there may be additional customer standards, local legislation and internal guidance to be considered.

All the definitions included in this catalogue are based on the listed documents.

- EN 12385-1:2009 – Steel wire ropes – Safety Part 1: General requirements
- EN 12385-2:2008 – Steel wire ropes – Safety Part 2: Definitions, designation and classification
- EN 12385-3:2008 – Steel wire ropes – Safety Part 3: Information for use and maintenance
- EN 12385-4:2008 – Steel wire ropes – Safety Part 4: Stranded ropes for general lifting applications
- EN 13411-3:2011 – Terminations for steel wire ropes – Safety Part 3: ferrules and ferrule-securing
- EN 13411-4:2011 – Terminations for steel wire ropes – Safety Part 4: metal and resin socketing
- EN 13411-5:2011 – Terminations for steel wire ropes – Safety Part 5: U-bolt wire rope grips
- EN 13411-6:2011 – Terminations for steel wire ropes – Safety Part 6: Asymmetric wedge socket
- EN 13411-7:2011 – Terminations for steel wire ropes – Safety Part 7: Symmetric wedge socket
- EN10244-2 – Steel wire and wire products – Non ferrous metallic coatings on steel wire – Zinc or zinc alloy coatings
- EN 10264-1:2002 – Steel wire and wire products – Steel wire for ropes – General requirements
- EN 10264-2:2002 – Steel wire and wire products – Steel wire for ropes – Cold drawn non-alloyed steel wire for ropes for general applications
- ISO 17558:2006 – Steel wire ropes – Socketing procedures – Molten metal and resin socketing
- ISO 4309:2010 – Cranes – Wire ropes – Care and maintenance, inspection and discard
- API 9A/ISO 10425:2003 – Steel wire ropes for the petroleum and natural gas industries – Minimum requirements and terms of acceptance
- API RP 9B:2005 – American Petroleum Institute recommended practice for application, care and use of wire rope for oilfield services
- Wire rope technical board – Wire rope user's manual 4th edition

Conversion factors

1	kg/m	=	0.672	lbs/ft
1	m	=	3.28	ft
1	mm	=	0.039	inch
1	kg	=	2.205	lbs
1	lb	=	0.0005	short t (ton)
1	metric t (tonne)	=	1.10	short t (ton)
1	metric t (tonne)	=	0.984	long t
1	kN	=	0.102	metric tf
1	N/mm ² (MPa)	=	145	psi

1	lbs/ft	=	1.49	kg/m
1	ft	=	0.305	m
1	inch	=	25.4	mm
1	lbs	=	0.454	kg
1	short t (ton)	=	2000	lb
1	short t (ton)	=	0.907	metric t (tonne)
1	long t	=	1.016	metric t (tonne)
1	metric tf	≡	9.81	kN
1	psi	=	0.0069	N/mm ² (MPa)

